

The New Orleans
blueprint
for safety

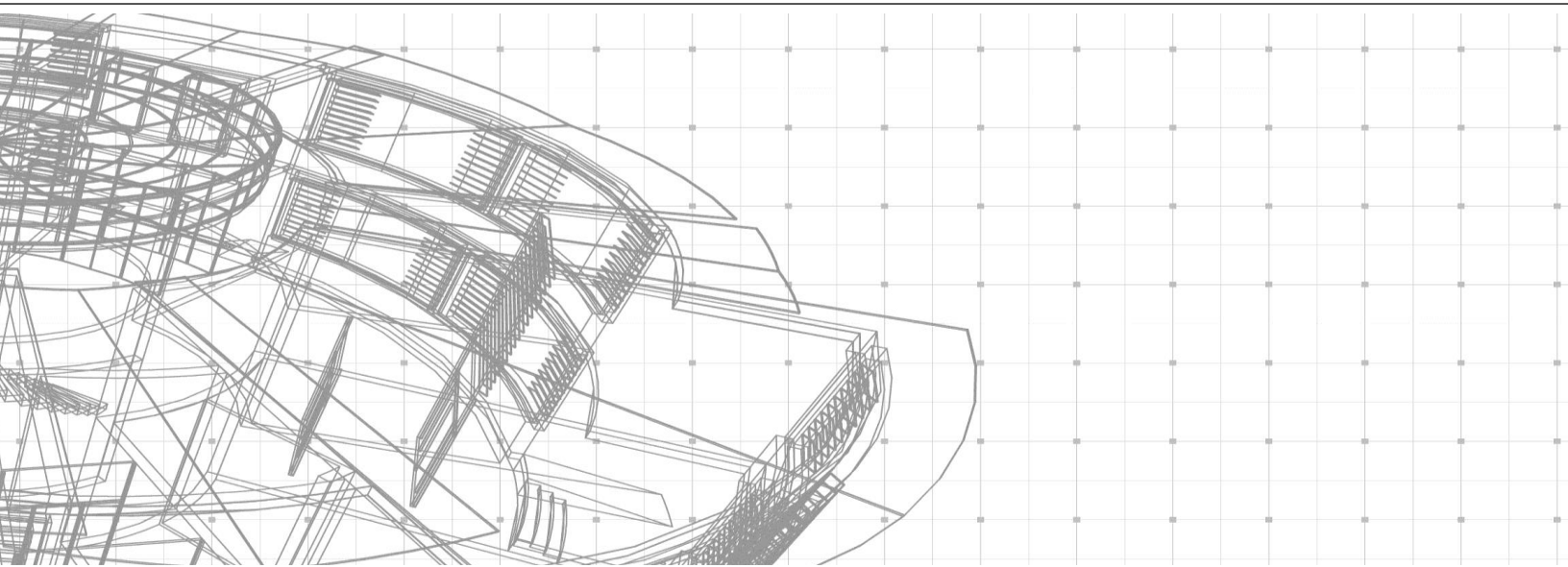

CITY OF NEW ORLEANS

Mitchell J. Landrieu, Mayor

Adopted October 21, 2014
Adapted from the Saint Paul *Blueprint for Safety*

This project is supported by Grant No. 2011-WE-AX-K001 awarded by the Office on Violence Against Women, U.S. Department of Justice. The opinions, findings, conclusions and recommendations expressed in this document are those of the author(s) and do not necessarily reflect the views of the U.S. Department of Justice.

For information on the *Blueprint for Safety* initiative in New Orleans:

Contact the City of New Orleans at 311 or (877) 286-6431 (toll free for callers outside of New Orleans) and ask for the Health Department's Domestic Violence Program.

The New Orleans *Blueprint for Safety* is available at:
<http://www.nola.gov/health/domestic-violence-prevention/>

For more information about the Saint Paul *Blueprint for Safety*, go to:

Saint Paul Police Department
www.stpaul.gov/police

Saint Paul Domestic Abuse Intervention Project
www.stpaulBlueprintspip.org

For more information about the Office on Violence Against Women/Praxis International Demonstration Initiative and to access training, assistance, and materials, go to:

Praxis International
www.praxisinternational.org

The New Orleans
blueprint
for safety

Archbishop Desmond Tutu tells us that justice demands three things: that the truth be told, that to whatever extent possible the harm be repaired, and that the conditions that gave rise to the injustice be forever altered.

The *Blueprint* is dedicated to all people whose bodies bear the marks of this injustice and to those who are committed to altering the conditions that give rise to this devastating form of violence.

Acknowledgments

The *Blueprint for Safety* was created in the City of Saint Paul in 2010 at the urging of ISAI AH—a coalition of 100 faith congregations—and through the collective work of ten agencies* with leadership by the St. Paul Police Department, St. Paul City Attorney’s Office, the St. Paul Domestic Abuse Intervention Project, and Praxis International.

Praxis subsequently produced a universal *Blueprint for Safety* for adaptation by communities across the country and was selected by the federal Office on Violence Against Women to implement the *Blueprint for Safety* Adaptation Demonstration Initiative (in partnership with the Battered Women’s Justice Project) to test the adaptability of the *Blueprint* in three jurisdictions: New Orleans, Louisiana; Shelby County/Memphis, Tennessee; and Duluth, Minnesota. Each site is adapting *Blueprint* policies and protocols to their local conditions and state laws; the lessons learned will be published at www.praxisinternational.org in 2015.

** 2nd Judicial District of Ramsey County, 2nd Judicial District Court Administration, Saint Paul Police Department, Saint Paul City Attorney’s Office, Ramsey County Attorney’s Office, Ramsey County Community Corrections, Project Remand, Ramsey County Emergency Communications Center, Ramsey County Sheriff’s Office, Saint Paul Domestic Abuse Intervention Project*

Office on Violence Against Women

A special thanks to the Office on Violence Against Women, U.S. Department of Justice, for the funding that supported this project, and for project guidance throughout.

Kevin Sweeney, Grant Program Specialist
Darla Sims, Grant Program Specialist

Technical Assistance

Praxis International provided technical assistance in adapting the Saint Paul *Blueprint for Safety*.

Denise Eng	Jane Sadusky
Cheryl Beardslee	Beverly Balos
Colia Ceisel	Julie Tilley
Maren Woods	

New Orleans Health Department

The New Orleans Health Department provided assistance to all project partners in drafting and developing the enclosed policies.

Charlotte M. Parent, Director of Health
Kati Bambrick Rodriguez, Domestic Violence Program Director
Amalfi Parker Elder, *Blueprint for Safety* Interagency Coordinator

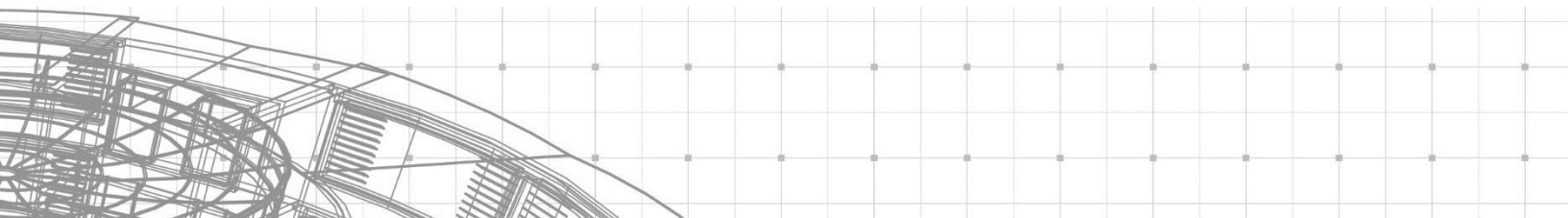

Acknowledgments

Participating Agencies

Each participating agency made its staff readily available to be observed, interviewed, and to engage in policy discussions and make recommendations. The openness of the agencies to an integrated response to domestic violence incidents made the *Blueprint* possible.

New Orleans Police Department

Michael S. Harrison, Superintendent of Police

Detective Eric Baehr

Captain Simon Hargrove

Sergeant Jean W. Jordan

Sergeant Richard J. Pari

Detective Karen Richardson

Zolite Caliste

Danny P. Murphy

Office of the Orleans Parish District Attorney

Leon A. Cannizzaro, Jr., District Attorney

Ginger Miller

Karen Avery

Erica Lotz

Graymond Martin

Ralph Brandt

Andree Mattix

Vickie Landry

Orleans Parish Sheriff's Office

Marlin Gusman, Sheriff

Sergeant Stephanie Minto

Lieutenant Inga Barre-Williams

Deputy Deidra Wagner

Tracie L. Washington

Major Rochelle Lee

Sergeant Djuana Bierria

Susan Lindsey

Domestic Violence Monitoring Court

The Honorable Benedict Willard, Chief Judge

The Honorable Tracey Flemings-Davillier

Darlene Winfield

The Honorable Harry Cantrell

The Honorable Gerard Hanson

Melissa Carter

New Orleans District Probation and Parole

Gerald Starks, Director

Jeff Badeaux

Adolph Lopez

Phyllis Sheridan

Frank Palestina

City of New Orleans Municipal Court

The Honorable Desiree Charbonnet

The Honorable Paul Sens

The Honorable Sean Early

The Honorable Joseph Landry

Mayor's Domestic Violence Work Group

Emily S. Arata, Deputy Mayor, City of New Orleans

The Honorable Bernadette D'Souza, Civil District Court

The Honorable Tracey Flemings-Davillier, Criminal District Court

Charlotte Parent, Director of Health, New Orleans Health Department

Michael S. Harrison, Superintendent of Police, New Orleans Police Department

Sergeant Richard J. Pari, Supervisor, Domestic Violence Unit, New Orleans Police Department

Graymond Martin, 1st Assistant District Attorney, Office of the Orleans Parish District Attorney

Mary Claire Landry, Executive Director, Family Justice Center

Dr. Pamela Jenkins, University of New Orleans

Tania Tetlow, Director, Tulane Domestic Violence Law Clinic

Dr. Jeffrey Rouse, Orleans Parish Coroner

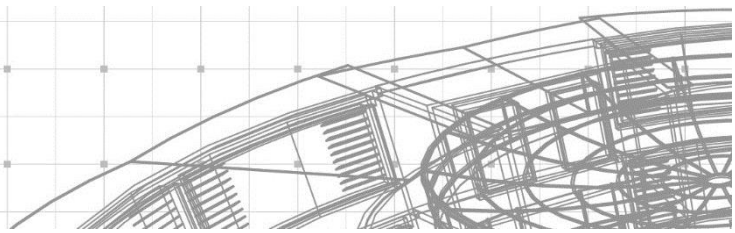

Acknowledgements

The New Orleans Family Justice Center (NOFJC)

The New Orleans Family Justice Center co-developed the vision for this project and acted as an advisor to the *Blueprint*, with contributions from Mary Claire Landry, Cory Turner and Deanne Bowman, in particular. Advocates from the following agencies also participated in practice assessment activities with the criminal justice system agencies, attended advocate focus groups or provided consultations to the *Blueprint* writers:

Anti-Stalking Program (C.C.R.)	New Orleans Children's Advocacy Center
Children's Bureau	Crescent House Healing & Empowerment Ctr.
Catholic Charities Immigration Program	Project SAVE – Catholic Charities
Southeast Louisiana Legal Services	Tulane Domestic Violence Law Clinic
Sexual Assault Program – Metropolitan Women & Children's Services	

The following individuals contributed their insight and expertise to the *Blueprint*:

Becki Kondkar, Tulane Domestic Violence Law Clinic
Rhonda Martinson, Rhonda Martinson Consulting, LLC
Kristine Lizdas, Battered Women's Justice Project
Bree Adams Bill, Saint Paul Intervention Program
Dr. Hillary Potter, Department of Sociology University of Colorado Boulder
Jacquelyn Boggess, Center for Family Policy & Practice
Jill Groblewski, Center for Family Policy & Practice
Sue Osthoff, National Clearinghouse for the Defense of Battered Women

In addition, we'd like to thank the many other advocates and community partners who participated in observations and interviews of the participating agencies, attended multi-disciplinary team meetings and advocate focus groups, and contributed their insight and expertise to the *Blueprint*.

The Disparate Impact Strategic Planning Committee (DISPC) was formed to address the *Blueprint* foundational principal of avoiding unintended consequences and disparity of impact in the development of our *Blueprint* policies. The DISPC primarily engaged the community of African American women in New Orleans who experienced or were arrested for domestic violence. Advocates from the following agencies held community focus groups, provided consultations to the *Blueprint* writers based on research, analysis of police reports, and years of experience in working with women in our community.

Institute of Women and Ethnic Studies	Dr. Pamela Jenkins, University of New Orleans
Women with a Vision	New Orleans Family Justice Center
Total Community Action	Golden Change
The Honorable Tracey Flemings-Davillier	Southeast Louisiana Legal Services
Kali Red's Initiative: Take Your Life Back Foundation	
Gwendolyn H. Richardson, Consultant & Project Director	
Orleans Parish Sheriff's Office Crime Victim Reparations	

To the women who participated in the focus groups, we thank you for your bravery and your insight.

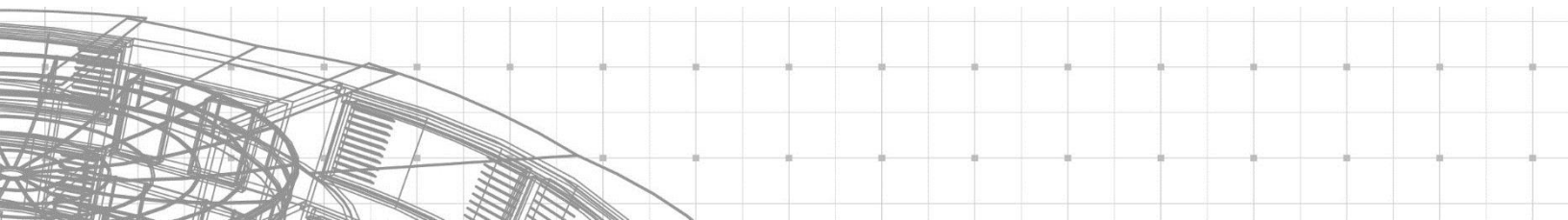

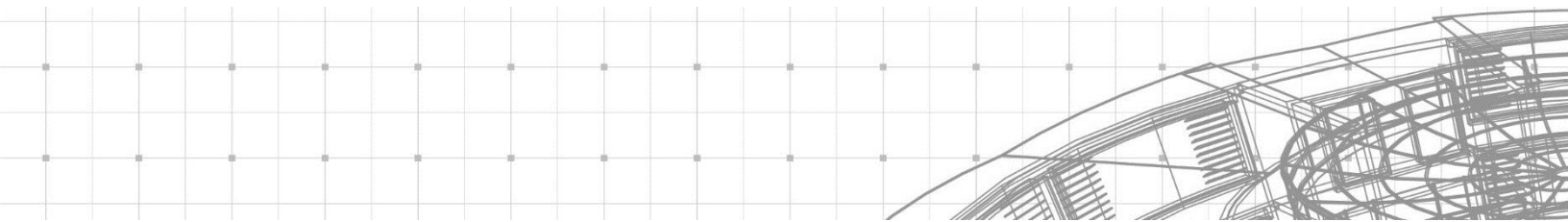

Table of Contents

Chapter One	Foundations of Effective Intervention
Chapter Two	911 New Orleans Police Department Communications
Chapter Three	Patrol Response New Orleans Police Department Platoon Officers
Chapter Four	Investigation New Orleans Police Department Domestic Violence Unit
Chapter Five	Prosecution Office of the Orleans Parish District Attorney
Chapter Six	Victim Witness Assistance Office of the Orleans Parish District Attorney, Victim/Witness Assistance
Chapter Seven	Jail and Bench Warrant Processing Orleans Parish Sheriff's Office
Chapter Eight	Pre-trial Release and Monitoring Orleans Parish Criminal District Court, Domestic Violence Court
Chapter Nine	Probation and Parole Supervision New Orleans District Probation and Parole
Chapter Ten	Court City of New Orleans Municipal Court
Chapter Eleven	Bibliography



CHAPTER ONE

Foundations of Effective
Intervention

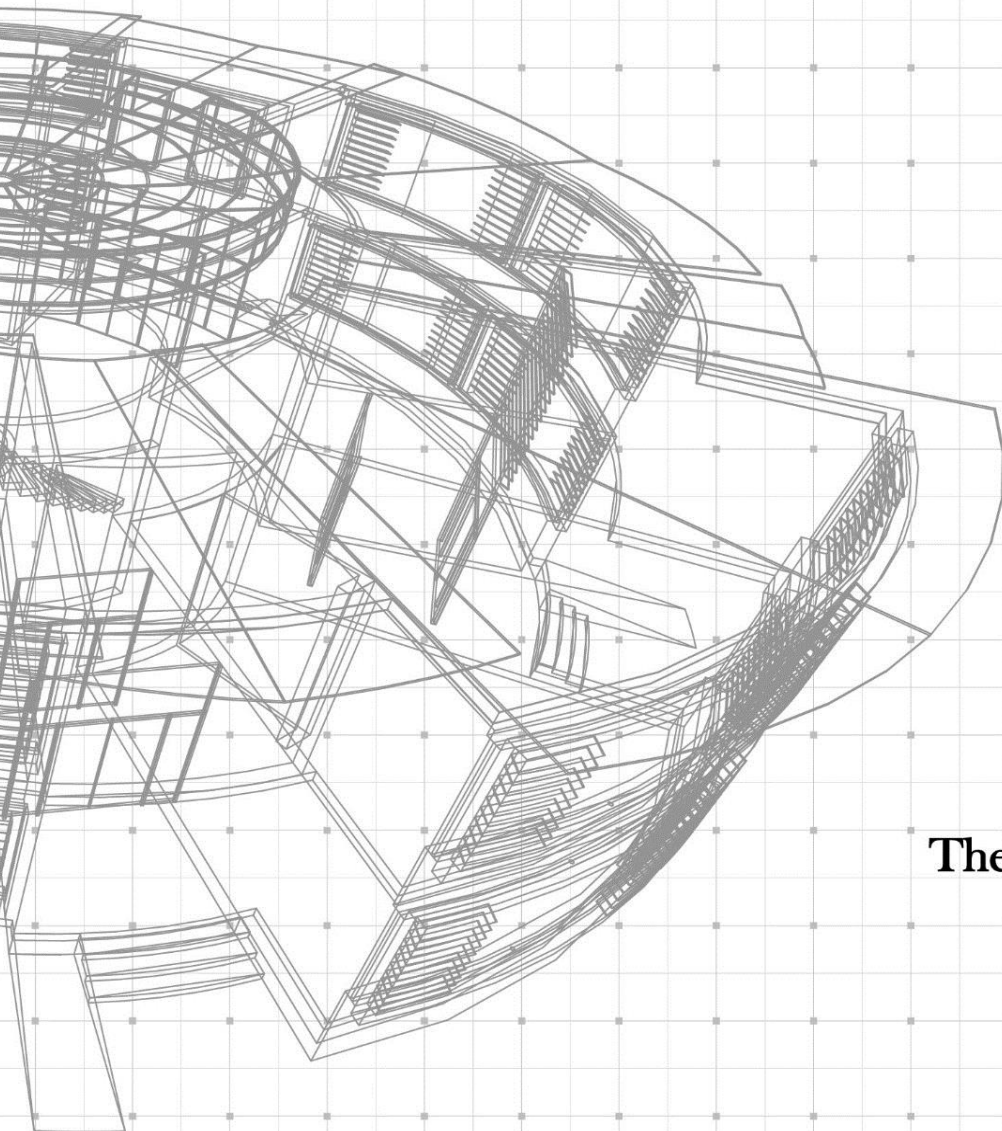

The New Orleans
blueprint
for **safety**

Foundations of Effective Intervention[©]

Copyright Praxis International, 2010. Used with permission.

NOTE: Chapter One conveys the design, intent, and principles of the Blueprint for Safety as created in St. Paul, MN. As part of the national initiative to adapt the Blueprint in other communities, New Orleans and other demonstration sites have been asked to include this chapter in its entirety as an introduction to the local adaptation.

Beginning in the 1970s, women across the country began to organize to call attention to the abuse of women by their husbands or male partners. They sought an end to this pervasive violence and its resulting death, injury, fear, and harm to women and their children and communities. As a result of this work, the first shelters were opened and advocates across the country began to lobby for changes in the law that would protect victims of abuse, including criminalizing this violence and establishing processes for obtaining civil protection orders. In the 1980s, proponents of change began to emphasize the need for agencies in the criminal justice system to work together more effectively and use interagency teams to share information and coordinate intervention. Duluth, Minnesota, became the first community to establish such a response and mandate arrest for domestic assault. The Duluth Model, as it became to be known, has been replicated throughout the country and around the world as communities have used the model to establish their own coordinated, interagency response to domestic violence cases.

Praxis International and the City of Saint Paul, Minnesota, took the next step of innovation in 2007 when they developed *The Blueprint for Safety*, a first-of-its-kind comprehensive approach for addressing domestic violence in the criminal legal system. The *Blueprint* integrates the knowledge gleaned from more than thirty years of research, demonstration projects, and practice into a “*Blueprint*” for city and county agencies responding to misdemeanor and felony assaults. The *Blueprint for Safety (Blueprint)* is the result of conversations and consultation with community members, practitioners, advocates, victims, defense attorneys, researchers, agency leaders, and experts in confronting this crime both locally and nationally. In the end, the leadership of the core intervening agencies and the district court bench create a successful *Blueprint Community*. Such leadership is the basis for any community’s effort to confront this devastating form of violence.

The *Blueprint* is anchored in six foundational principles we have identified as essential characteristics of intervention that maximize safety for victims of domestic violence and holds offenders accountable while offering them opportunities to change.

- Adhere to an **interagency approach** and collective intervention goals
- Build attention to the **context and severity** of abuse into each intervention
- Recognize that most domestic violence is a **patterned crime** requiring continuing engagement with victims and offenders
- Ensure **sure and swift** consequences for continued abuse
- Use the power of the criminal justice system to **send messages of help and accountability**
- Act in ways that **reduce unintended consequences** and the disparity of impact on victims and offenders

Endnotes highlighting research findings, academic literature, and intervention models supportive of these foundational elements can be found at the end of each chapter, with a complete bibliography found in chapter 10.

1. Interagency approach and collective goalsⁱ

Processing a single domestic violence related case involves five levels of government and over a dozen intervening agencies. Hundreds of practitioners might touch these cases every day. An effective response, meaning one that leads to an end to the violence, requires *solid coordination* across and among the many practitioners involved, as well as a strong *system of accountability*. Practitioners are committed to the mission, function, and goals of their respective agencies, but in an interagency approach they are simultaneously accountable to the victim on whose behalf we intervene, to the offender with whom we intervene, and to others intervening in the case. This interagency approach requires a *system of communication* in which each practitioner receives and relays information in ways that make it possible for everyone to act with the best knowledge of the case. The legal system is structured to assign distinct roles with specific powers to create a system of checks and balances that prevents the misuse of State power. That system is the backbone of our justice system. That doesn't mean however, that practitioners in these various roles should not attempt to agree on some shared assumptions about risk management, deterrence and safety. In fact, the absence of a cohesive approach often thwarts the possibility of justice in these cases. Finally, an effective interagency response requires a *commitment to excellence* by each intervening agency and practitioner, as well as *a commitment to challenge one another and actively engage in resolving disagreements*. When so many agencies are involved in case processing there will be differences, arguments, and unmet expectations; this is not the problem. The problem arises when there is no ongoing structured way to resolve those conflicts. Interagency approaches succeed when everyone focuses on a shared goal that is centered on the needs of the victims and families harmed by the violence and brutality.

The criminal court process demands a high level of coordination to carry out the dozens of case processing steps involved in the response. The criminal codes, rules of evidence and procedure, case law, administrative forms and processes, calendars and schedules, databases, and information sharing protocols dictate how interagency collaboration is organized. This *Blueprint* provides additional structure by introducing coordinating elements designed specifically to enhance approaches to domestic violence related cases:

- In a criminal domestic violence case that involves over one hundred institutional steps, the *Blueprint* creates **written policies** for each core processing point. Beginning with the 911 operator and ending with the probation officer who discharges a case months or even years later, each policy is written with every intervener's needs in mind. The *Blueprint's* interlocking policies serve two goals: to standardize research-based practices and processes so that the public as well as system practitioners can count on a consistent, effective, and fair response; and to bring agencies with distinctive missions and goals together under a common set of collective goals centralizing victim safety and offender accountability. By agreeing on some fundamental intervention principles, we offer both victims and offenders a system that is clear in its messages, expectations, and actions.
- Each policy is accompanied by **administrative protocols or procedures** that coordinate workers' actions while simultaneously avoiding turning each practitioner into a robot, devoid of professional skills and judgment. Every form, matrix, set of guidelines, report writing format, and assessment tool has been designed to address the unique characteristics of this crime and the interagency nature of case management.
- Via a **system of documentation and information sharing**, each intervention step is woven together with subsequent steps in case processing. The legal system is a text-based system. What a law enforcement officer is trained and required to record about an incident has an impact on charging, trial decisions, sentencing, probation conditions, and rehabilitation programming. Risk scales, charging guidelines, and sentencing matrices are significant factors in how a complex institution processes thousands of cases. The *Blueprint* uses new and enhanced approaches to gathering, recording, and disseminating information on cases. This information sharing system is linked to agreed-upon intervention goals in domestic violence cases and to efforts to coordinate interventions across agencies.
- Each policy also sets a foundation from which agencies and practitioners can clearly delineate their respective **roles and functions**. A multiagency coordinated response requires connections between and across practitioners so that it is impossible to lose sight of the nature of the harm, the likely danger, and the opportunities for action and change in each case. The *Blueprint* calls on each practitioner in each intervening agency to be oriented toward collective goals, as well as toward those of their own agencies. Those collective goals are to (a) protect adult and child victims from ongoing abuse, (b) impose meaningful consequences for the harm, (c) help offenders who are willing to change, and (d) reduce the unintended negative consequences of state intervention for individuals and communities.

2. Attention to context and severity

Domestic violence is a broad category that has come to include many kinds of behaviors within relationships between family and other household members. It jumbles together vastly different actions: from throwing a shoe at a partner who gambled away \$1000, to strangling a woman until she loses consciousness because she wants out of the relationship. It groups together slapping someone on the arm with head-butting. The term domestic violence focuses attention on specific

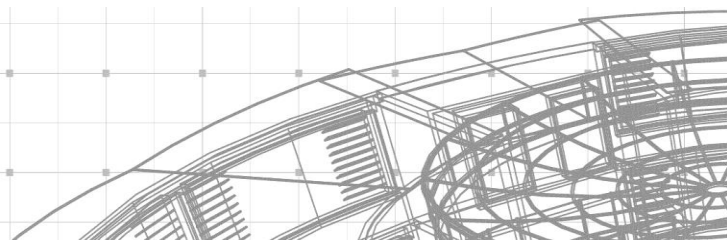

acts of violence toward a family member and obscures the context of that violence, which often includes ongoing coercion, intimidation, and emotional harm.

What has been largely submerged under the category of domestic violence is **battering**: a term recognized, defined, and brought to public attention in the 1970s by advocates responding to the realities of sustained abuse in women’s lives, primarily by their intimate partners. Battering came to describe an ongoing pattern of coercion, intimidation, and emotional abuse, reinforced by the use and threat of physical or sexual violence.ⁱⁱ As laws were enacted to protect victims of battering and hold batterers accountable, the term “domestic violence” was adopted both to be inclusive of cases where a male is the victim and to emphasize the place where the abuse is occurring, the home. Every act of violence by one person against another that occurred in the setting of the home came to have the same meaning; that is, all violence involving family members became acts of domestic violence. Laws passed with battering in mind were applied to teenagers hitting their parents, to one brother hitting another, to a husband strangling his wife, and to that wife scratching her husband in response. Slogans like “zero tolerance for violence in the home” hindered critical reflection about the differences between these acts of violence.

We have learned that applying a single treatment to such a broad range of human interactions and behaviors inhibits meaningful intervention for victims and perpetrators.ⁱⁱⁱ For example, grouping all acts of violence together, regardless of intent and context, leads us to treat a battered woman or a teenage child who reacts to abuse with violence (albeit illegally) the same as the person who dominates his partner through a pattern of fear, coercion and violence. Placing all acts of relationship violence into a single category of “misdemeanor domestic violence” or “felony domestic violence” can distort our understanding of who is doing what to whom, and who needs what level of protection from whom. For victims of battering, such misunderstandings are not benign and they can have fatal effects, as analysis of intimate partner homicide confirms.^{iv}

Our challenge is to make visible all that we can possibly know about the full scope of abuse occurring in a relationship.^v Interveners must be able to see the scope and severity of the offender’s violence, how often and under what circumstances it is occurring, and the pattern of the abuse: is it escalating, deescalating, potentially lethal, or unpredictable? We were tempted to build the *Blueprint* around typologies of domestic violence offenders, but in the end decided that such an approach presented too many due process and safety traps. Instead, we have built differentiation into each step of the process, supported by intense attention to gathering, documenting, disseminating, and building on new information over a period of time and frequent, ongoing contact with offenders and victims. This differentiation will allow us to design a system that tailors interventions to the specifics of a case and accounts for the unique aspects and different levels of violence and abuse that offenders use and to which victims are subjected.

This process of differentiation is not new to the *Blueprint*. Law enforcement experts and state legislatures have recognized the need for differentiation by passing laws that discourage dual arrests even when evidence exists to arrest both parties in a domestic abuse-related case. Instead, these laws

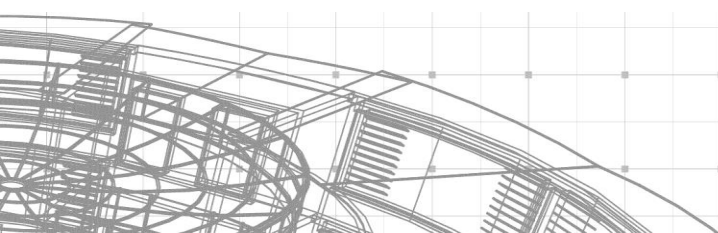

encourage officers to arrest the predominant aggressor. Other laws give prosecutors the ability to respond to the ongoing nature of this crime by allowing but not requiring enhancements for repeat offenders. This powerful discretionary tool permits prosecutors to respond to the specifics of a case in new ways.

To respond to domestic violence without inadvertently causing further harm requires differentiating who is doing what to whom, and with what impact. The *Blueprint* directs practitioners to gather information that illuminates both the pattern of abuse and the specific acts being committed. Policies and protocols then propose different interventions based on the circumstances, frequency, and severity of abuse.

3. A patterned crime requiring continuing engagement

A domestic violence crime is rarely fully resolved with the first intervention.^{vi} For those offenders who have much to lose by criminal justice intervention, a single legal action may be enough to jolt them out of thinking that violence is an effective way of dealing with their relationship. For another group of offenders who batter, the violence will not stop or decrease significantly in severity until there are repeated interventions. There is a small but volatile group with long and violent criminal histories for whom sanctions have little or no impact. If the violence is caused by mental illness, brain trauma, or similar factors, multiple and very specific interventions may be necessary.

With the clear exception of stalking, most domestic violence– related criminal interventions focus on a single event of violence. But most practitioners charged with intervening in domestic violence cases understand that these single acts of violence are usually part of a patterned use of coercion, intimidation, and the use or threat of violence—namely, battering. As such, the relationship is characterized by a “continuing” set of violent actions committed over time and in countless situations. Interventions to process one assault look different than interventions intended to stop the continued use of abuse and violence.^{vii} The *Blueprint* is designed to do both: to process the “event of a crime” in a manner that confronts and stops the pattern of abuse and violence.

This dual approach to intervention has important implications for an interagency approach. First, we must be prepared to link seemingly isolated incidents into a more coherent picture of behavior and complexity of risk and safety for any one victim. Second, we must all see our shared task and function as reaching beyond the processing of that single event to stopping future abuse. Without significant change on the part of the offender, the coercion and violence is likely to continue and may escalate in severity and frequency.

The patterned nature of battering means that our contact with a victim or offender will likely continue for an extended period of time. This extended contact provides the opportunity to build relationships that reinforce safety and accountability in more lasting ways. If a victim is reluctant or refuses to participate in a prosecution and court intervention at a given point, how we treat her or him will shape the possibilities for a future partnership.^{viii} As an investigator explained:

If I treat her with respect and let her know I'm concerned the first time I meet her, when it happens again she is more likely to take my call, or even call me. If I get frustrated and angry because I need her in order to get to him and I throw up my hands, saying 'fine, you want to live that way go ahead,' then I'm just one more person slapping her in the face.

As two patrol officers noted:

What I do and say the first time we go out on a case sets the tone for what the next officer faces. If she's hostile and in my face and I treat her with respect and let her know we are here for her and her kids when they need us, the next officer (or maybe even the one after that) will be dealing with a different person...

Let's just put it this way, I'm not the one getting bashed up and pushed around and treated like an animal, so I'm in a better position to extend that hand. It might take two or three of us and different calls, but eventually most women get to a point where the police aren't the enemy and then they want to work together...

To produce a more meaningful and individualized response we must collaborate with victims in ways that acknowledge the nature of domestic violence as a patterned offense. This means:

- Wherever possible, minimize the victim's need to confront the offender.
- Protect the victim from retaliation when using information that she or he has provided.
- Treat each interaction with the victim as an opportunity to build collaboration over multiple interventions (even when a victim starts out hostile to those interventions).
- Stay mindful of the complex and often dangerous implications of a victim's collaboration with interveners.^{ix}
- Be aware that the fundamental purpose of battering, which characterizes the majority of domestic violence criminal cases, is to control what the victim says, thinks, feels, and does.^x
- Engage in a dialogue with the victim rather than treating her or him as a data point.
- Avoid unintentionally reinforcing the abuser's actions: offer a clear alternative to messages that the victim is crazy, at fault, unbelievable, and unable to make decisions, and that the abuser is unstoppable.^{xi}

4. Sure and swift consequences

In the criminal justice field, it is widely believed that sure and swift punishment is more important than severe punishment. Research into domestic violence shows this to be particularly true in confronting this crime. Evidence suggests that building sure and swift consequences into the infrastructure of case processing can reduce recidivism in some cases and the severity of ongoing abuse in others.^{xii}

The national data is encouraging, although day-to-day work in the criminal justice system can leave many practitioners frustrated and skeptical that the changes made over the past several decades have not reduced violence.

Batterers tend to push against any boundary set for them.^{xiii} The clearer we are about what behavior is and is not acceptable, the more likely the abuser is to live within those boundaries. Each policy and administrative protocol in the *Blueprint*, from the initial law enforcement contact through case closure, is designed with the goal of sure and swift consequences in mind, but also with the recognition that sometimes intervention goals can conflict. For example, if a probationer is arrested for assaulting his former partner, that new case may take months to resolve. The decision to pursue an immediate probation violation for committing a new offense is weighed against the possibility that the violation hearing might pose problems for the new case, which carries a more substantial and enhanced penalty. A prosecutor might prefer to wait for the new conviction to avoid such complications. However, waiting might result in the defendant having free license to harass the victim, particularly if the defendant is aware that all new cases will be rolled together and treated as one in the end. One course of action—pursuing the probation violation—reinforces swift consequences. The other course of action—pursuing an enhanced gross misdemeanor—may reinforce more substantial consequences. The *Blueprint* policies and protocols address these dilemmas, sometimes with a mandate requiring practitioners to take certain actions, sometimes with a set of guiding principles or procedures, and sometimes with a training memo suggesting how to weigh the different outcomes.

The Blueprint

uses interagency policies, protocols, case processing procedures, and information sharing to (a) maximize the state’s ability to gain a measure of control over a domestic violence offender; (b) use that control to intervene quickly when there are new acts of violence, intimidation or coercion; and (c) shift the burden of holding the offender accountable for violence or abuse from the *victim* to the *system*.

5. Messages of help and accountability

The single greatest obstacle to the criminal justice system’s effective intervention in battering cases is the degree of psychological and physical control the abuser has over the victim.^{xiv} Batterers rely on the power they have over the victim to shield them from legal interventions. Therefore, the ability to work with a victim of battering hinges on her/his belief that (a) our intervention will counteract that power, (b) we understand the reality of living with battering, (c) we have a collaborative approach to

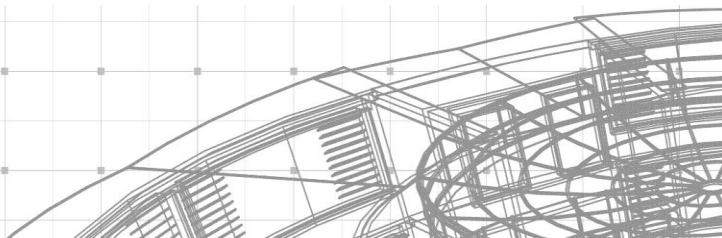

working with her or him, and (d) we are here to help, however long it takes.

The State, and by extension the practitioners who represent it, has a powerful influence over people. The messages given to victims, offenders, and children at each point of intervention can have a deterrent effect or, alternatively, can fail to deter and therefore act as an opening for more violence.^{xv}

Consider two linchpin characteristics of battering cases involving heterosexual men.^{xvi} First is the batterer's sense of entitlement to his actions. His partner is the target of his violence not so much because of *what she did* as *who she is*. Research has shown that a cognitive behavioral approach that challenges the abuser's belief systems about his rights and entitlements in intimate relationships is more effective than any other rehabilitation approach.^{xvii} That approach can begin with the dispatcher and responding officer. If every intervening practitioner is coherently and consistently "on-message" the path to a rehabilitation program will be well-worn before a batterer enters his first group. This cannot happen when each practitioner offers his or her distinct and often competing message about what lies at the root of the problem and what will fix it.

Effective interventions with an offender who is a batterer are respectful, but also clear and consistent, that there will be a consequence every time the offender violates a sanction or requirement. This consequence will be sure and swift and it will be linked to what the person chose to do. For a man who batters a female partner, a previously absent message will now suddenly be very clear: he will be held accountable for the harm he has caused. Offenders need to know that the system is coordinated, the players speak to each other, and they cannot successfully play one off against the other. Most importantly, batterers have to see that the violence, coercion, and intimidation are the focus of the state's intervention, and not the victim's behavior. In this specific respect, there is no neutrality available to law enforcement officers, prosecutors, or judges; every message either challenges an abuser's sense of entitlement or reinforces it.

The second linchpin characteristic of battering is the batterer's domination of the victim—not only physically, but often economically, socially, emotionally, psychologically, and legally.^{xviii} The practitioner who talks to the victim in terms of, "*Look what happened: he hit you once, he'll hit you again,*" misses the complex nature of batterers' domination of their victims and the far-reaching implications of that domination on the lives of women and their children. The abuser's messages to his partner are often linked to her cultural, economic, religious, or spiritual identity^{xix} "*No one will believe you... no one will help you... they all know you're crazy... you're disgracing the clan (or family)... they'll take your kids... a good (Native, African American, Christian, Hmong, Jewish) woman doesn't shame her husband this way... what about the things you've done: your drinking, your visits to the shrink?... everyone knows you're bipolar... I'm a (cop, minister, lawyer, doctor, hero in this town, stable business- man), who would believe you over me?... think of the family... the children need a father, you're taking that away.*"

Our messages to a victim need to be cognizant of the relentlessly destructive messages she has been told and on some level has come to believe. As interveners, every action we take and every statement we make can and should be aimed at an efficient, consistent, coherent, clear message that

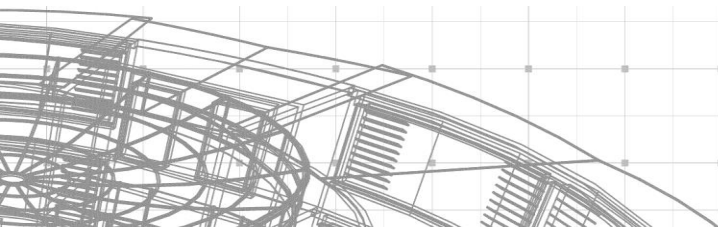

strips the abuser of his most powerful weapon: his message that “they can’t and won’t help you.”^{xxx}

Two caveats require attention here. First, not all cases of domestic violence involve heterosexual men *battering* women. Some involve gay men battering their partners. People with significant mental health problems may assault partners outside of the context of battering. Similarly, a small percentage of drug addicted domestic violence offenders do stop abusing their partners when they stop using drugs. Victims of battering who fight back illegally do not fit the profile we have described above. There are also women who batter their partners—primarily in lesbian relationships, but sometimes, though rarely, in heterosexual relationships. While cases involving battering by men are the vast majority processed in the criminal justice system, when practitioners encounter cases that do not involve men battering women, they need to adjust their interventions accordingly.

The second caveat is a reminder that in the courtroom the offender is presumed innocent until proven guilty. Practitioners relay messages at every point of contact with the offender and victim. Most of those points of contact are pre-conviction. Practitioners must walk a fine line between presuming guilt and being helpful and clear with suspects and victims.

Practitioners have the opportunity to counteract the messages associated with a batterer’s defense for the violence.^{xxi} A batterer (i.e., someone who engages in a continuous pattern of violence and abuse) has basically seven defenses, each with a supporting message. Those messages are: a) I didn’t do it; someone else did, b) the victim is lying, c) it was an accident, d) it was self-defense, e) it can’t be proved, f) yes, I did it, but you’d do it too in my situation; have you met her? Or g) I did it, but the officer messed up; they can’t convict. Batterers do not even need to present these defenses when they can rely on their victims to be unavailable to counter or challenge the defenses. Most abusers discourage victims’ participation and reinforce the message that interveners cannot or will not help. Sometimes they do this in blatantly illegal ways; other times they rely on their power over the victim. Our pressure on a victim to cooperate and the protection we can offer is matched and often overpowered by the pressures a batterer can apply and the consequences he or she can impose for that cooperation.

The *Blueprint* is embedded with a set of messages that, if coordinated across practitioners and intervening agencies, can contribute to lower recidivism, increased engagement with victims, and less resistance from abusers to the state’s role in confronting the abuse. The *Blueprint* extends messages of help: to protect victims and to provide offenders with opportunities for change. It also extends messages of accountability: individual accountability for the harm caused by battering; interagency accountability in building and sustaining an effective response; and intervention’s accountability to ensuring protection for victims and fair, respectful treatment of offenders.

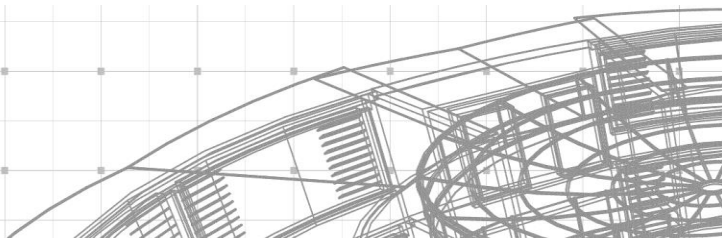

6. Reducing unintended consequences of interventions and the disparity of impact

We do not all experience the world in the same way. People’s social realities are constructed by differences in class, age, race and ethnicity, immigration status, sexual orientation, history, privilege, and many other aspects of culture and identity. As a result, we do not all experience battering in the same way, or the actions of interveners, or the impact of policies.^{xxii} An effective domestic violence intervention accounts for the realities of peoples’ unique circumstances and social standing. For example, our intervention strategies must address the relationship between violence, poverty, homelessness, gender, and race. Our interagency approach must reduce rather than emphasize the disparity between groups of people with different social realities. Reducing disparity requires us to find ways to sustain compassion for the people we encounter. Working in and around the criminal legal system in general—and responding to domestic violence in particular—is stressful, demanding work. We are constantly dealing with aspects of peoples’ lives that are harmful, chaotic, and cruel. It is far too easy for a corrosive cynicism to set in that dismisses those before us as unworthy of help and attention, and diminishes the kind of problem solving that fosters safety and accountability on both individual and systemic levels.

Almost every practitioner in the system can cite a case where everyone did his or her job and every policy was followed, but the outcome of the case was neither just nor protective of the victim. In these familiar cases, the poor outcome is as much due to failures in our intervention strategies as it is about specific abusers. Effective intervention cannot be a blanket, one-dimensional response. Truly implementing the concept of equal treatment under the law requires thoughtful legal interventions that produce just outcomes. Under what circumstances should we adjust for the impact of policy and practice on peoples’ different social realities? Whenever possible, the *Blueprint* introduces ways in which practitioners can reduce the level of disparity produced by their interventions.

Conclusion

The *Blueprint* incorporated input from hundreds of experts, beginning with dozens of victims of abuse who attended focus groups and pinpointed specific ways that interventions could better promote their safety. These experts also included 911 call takers and dispatchers, Sheriff’s Department warrant officers and jail staff, law enforcement officers, prosecutors, probation agents, and judges. Community-based advocates and advocates located in the County Attorney’s office weighed in on the design. A national team of researchers helped us deliberate nearly every line of the *Blueprint* with supervisors from each participating agency.

According to the Violence Policy Center’s study of 2012 Homicide Data, 1,706 females were murdered by male perpetrators in 2012 (in single victim/single offender incidents). 93% of women killed nationwide knew their assailants, who were usually current or former husbands or boyfriends.^{xxiii} They have been shot, stabbed, strangled, and beaten to death, often with great brutality and often in the presence of or during an attack against their children as well. Unreported are the countless “near homicides”—non-fatal thanks to prompt medical attention—and the even

greater number of people who endure ongoing and daily coercion, intimidation, and violence with devastating impact.

In the past thirty years, we have come a long way to building working relationships, alliances, and collaboration among advocates, law enforcement, prosecutors, probation agents, and other interveners, both with one another and with victims. These relationships have produced a far more intentional and effective approach to community intervention in what was once considered a private crime. This effort has significantly reduced intimate partner homicides overall and introduced options for victims of domestic violence that were unheard of in our parents' and grandparents' time. It has meant that women, who are most often the victims of domestic violence, live for far shorter periods of time in an abusive relationship, as do their children. The work is by no means complete, however, and the *Blueprint for Safety* is the next wave of change, grounded in this knowledge and experience.

We have learned that each encounter between someone living with this violence and a practitioner in the “system” is an opportunity to interrupt the actions and patterns that sustain battering. The *Blueprint* organizes us to present a cohesive set of messages to victims and perpetrators. To adult victims: a) we're here to help when you're ready for that help; b) the violence is not your fault and you are not responsible for the perpetrator's actions; and c) I'm concerned for your safety—by working together we have the best chance of stopping the violence. To children: a) you haven't done anything wrong—it's not your fault; b) we want everyone to be safe and we're here to help you and your family; and c) we won't hurt your father or mother. To perpetrators: a) the violence must stop—there is help for you to do that and there will be consequences if you don't; b) this arrest (or prosecution or probation) is a result of your actions and not the actions of others; and c) this is an opportunity for you to change, to reject the violence and repair the harm you have caused, and we can help you do that. In its structure and content, the *Blueprint* prepares agencies and practitioners across the criminal legal system to carry these messages with one voice.

Underlying Assumptions in the *Blueprint*

In our grandparents' generation, women had few options for finding safety from battering. There were no organized shelters or religious or community support systems challenging the abuser (although informal confrontations occurred in many communities). Law Enforcement was expected to calm the situation down and leave. All but the most serious assaults were screened out of the system and the few arrests that occurred were rarely prosecuted. That all changed with the opening of the first shelter for battered women in 1974 and the first interagency intervention project in 1980. The last thirty-five years have seen enormous changes in the state's response to intimate partner violence. For the first time in history, the state's obligation to protect its citizens was applied to “wives.”^{xxiv}

In any society, widespread use of violence, aggression, and coercion in families is a cultural phenomenon. Such violence is rooted in unjust social structures which the criminal justice system alone cannot unravel. The criminal justice system plays two important roles in reducing violence in families, however, by (1) enforcing laws which criminalize a once accepted cultural practice (similar to the legal system's impact on drinking and driving, child labor, sexual harassment in the workplace, and exposure to secondhand smoke); and by (2) stopping individual abusers from doing more harm. It is one of many institutions that convey social norms and reign in unacceptable behavior. It strives to accomplish this in domestic violence by responding with sure and swift consequences to those whose battering makes the home a place of fear rather than a place of refuge.

For almost three decades, advocates have raised the voice of concern that too little is being done to stop the violence. Researchers have sent mixed messages about what works and what does not work. Organized opposition to reform has grown. As one criminal court judge shared with a colleague:

I've always thought that in domestic violence cases I could be the only person in the courtroom—no defendant, no victim, no attorneys; not a clerk or deputy in sight, not a motion to rule on or decision to make—and still I'd be absolutely sure I was doing something wrong.

The judge's frustrations are shared by many in the criminal justice system. Intimate partner violence is a complex type of crime. The offender's control over the victim can make effective intervention incredibly difficult and time-consuming in a resource-starved institution. The good news is that our overall strategy of using the legal system to stop the violence has made a difference, particularly in homicide rates. Spousal homicides overall dropped by 46% between 1976 and 2004. The number of black males killed by their partners dropped an astounding 82%, black females by 56%, and white males by 55%. Between 1976 and 1992, there was also a 48% drop in severe violence.^{xxv} Battered women and their children face a very different reality today than did our grandmothers.

Yet few in the "system" are comforted by these statistics when law enforcement calls and courtroom calendars are still overflowing with domestic violence-related cases. The *Blueprint* proposes the next level of change. It rests on years of experience in interagency coordination; research on arrests, sentencing, and treatment of batterers; statistical trends; and a year-long process of interagency negotiation in Saint Paul. The policies and protocols are designed to guide every practitioner to do everything possible each time a person reaches out to this mammoth institution for help. Each assumption underlying the *Blueprint* is supported by research. The *Blueprint* is an attempt to integrate what we have collectively come to understand as best practices in the criminal justice system response to domestic violence. Those assumptions include:

- When work is coordinated across agencies and within agencies, the overall capacity to protect is increased.
- The action of one practitioner is strengthened by the cumulative effect of coordinated actions across the criminal justice system.

Chapter One: Foundations of Effective Intervention

- When the system is organized to treat a case as part of an ongoing pattern of criminal activity rather than a singular event, outcomes improve.
- Interagency coordination is strengthened when information is organized around common risk markers that are uniformly collected and shared.
- Not all domestic violence is the same; interventions are different for violent acts that lack a context of coercion, intimidation and control (e.g. cases of mental illness, isolated events, victims of abuse reacting).
- Sending clear and consistent messages of offender accountability and victim safety can reduce the violence.
- Whenever possible we must shift the burden of confrontation from the victim to the intervening practitioner.
- Danger and repeat violence from the perpetrator can be anticipated when certain actions and behaviors are visible.
- It is important for every act of aggression by the offender to be met with sure and swift consequences.
- Intervention policies and protocols should be adapted to diminish unintended consequences that adversely affect marginalized populations.

Archbishop Desmond Tutu tells us that justice demands three things: (1) that the truth be told, (2) that the harm be repaired to whatever extent humanly possible, and (3) that the conditions that gave rise to the injustice be changed. The *Blueprint* envisions and builds a path to all three for those subjected to violence, aggression, and coercion in their intimate relationships and families.

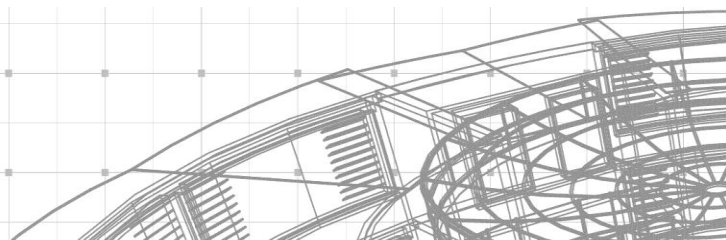

Practitioners' Guide to Risk and Danger

The following is an abbreviated list of factors related to risk and danger in domestic violence. Most of the research is based on violence toward women, which reflects the majority of cases coming into the criminal justice system. The presence of these indicators suggests that one of the following outcomes is likely without effective intervention: the violence will (1) continue, (2) escalate, and/or (3) become lethal.

Practitioners should not assume that the Guide to Risk and Danger lists every possible risk marker for continued violence or lethality. Instead, the Guide uses key categories of risk to identify the indicators of severe violence or lethality. Every practitioner should be familiar with, look for, and document the key categories of risk and danger included in the guide. They can then weigh this information from the research with their own experience in domestic violence cases and the conditions highlighted in the guide as particularly associated with increased risk and lethality. When there is violence without these risk factors, practitioners should consider the probability that this is a case of either resistive violence or non-battering related domestic violence.^{xxvi}

While a victim's perception of danger can be a very powerful predictor of re-assault, 47% of victims of femicide failed to recognize the potential for lethal violence or attempted murder.^{xxvii} **At a minimum, an intervening practitioner should always ask a victim:**

- How recent was the last violence?
- Is the violence increasing in frequency?
- What types of violence and threats are you experiencing?
- Do you think [the offender] will seriously injure or kill you or your children?

Practitioners' Guide to Risk and Danger

Using this risk guide

- ❑ Each Blueprint protocol includes specific instructions for documenting and responding to risk. Practitioners should also read *Appendix 1B: Training Memo—Risk and Dangerousness*.
- ❑ Elicit and document the risk factors contained in this guide. Whenever possible, talk with the victim; engage in a discussion about danger rather than just asking if these things have happened. Victim perceptions and interpretations are important.
- ❑ Communicate risk factors to other intervening practitioners in a timely manner.
- ❑ Be attentive to the factors in a given case; use experience, common sense, and training to make judgments about the level of danger that both the offender and the set of circumstances pose.
- ❑ Adjust the response to each case based on the level of risk and dangerousness.
- ❑ Protect the victim from retaliation when soliciting or using safety and risk information.
- ❑ Link victims with risk factors to an advocate.
- ❑ Stay alert; the level and type of risk will likely change over time and as circumstances change. Determining and managing risk is an ongoing process.
- ❑ A victim's attempt to terminate the relationship is a major change that poses increased risk.
- ❑ Victims' perceptions of high danger are typically accurate; their perceptions of low danger are often not.

Acts or threats of violence associated with risk & lethality

Factors listed in italics are particularly associated with lethal violence

- *Stalking*
- *Strangulation; attempts to "choke"*
- *Threats to kill the victim*
- *Threats to kill that the victim believes or fears*
- *Threats to kill that are conveyed to others*
- *Threats of suicide*
- *Forced sex or pressuring for sex even when separated*
- *Serious injury to the victim*
- *Carries, has access to, uses, or threatens with a weapon*
- *Violence outside of the home*
- Aggression toward interveners
- Threats to family, coworkers, victim's new partner
- Animal abuse or killing pets
- Damages victim's property
- Violent during pregnancy or shortly after birth
- Hostage-taking; restraint
- Acts exhibiting extreme hostility toward the victim

Coercion

Violence with a pattern of coercion is a serious marker of high risk violence. Coercion may be displayed as control of children, finances, or activities; sexual aggression; intimidation; hurting pets; or isolating the victim from support systems.

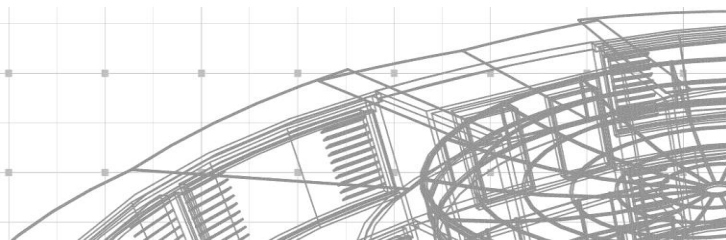

Risk is higher when the violence is accompanied by:

- *An increase in frequency, severity, or type of violence over recent months*
- *Almost daily impairment by alcohol or drugs*
- *The victim attempting a permanent break*
- *Estrangements, separations, and reunions*
- *Failure of prior interventions to affect the offender*
- *A victim who expresses fear of threats to kill*
- *A victim making no attempt to leave despite severe abuse*
- *Prior arrests, law enforcement calls, and/or protection order(s)*
- *Isolation of victim (physical or social)*
- *A victim seeking outside help in the past year*
- *A victim has a child who is not the offender's*
- *An abuser leaves before law enforcement arrive; eludes warrants*
- *An abuser's:*
 - *Lack of remorse*
 - *Mental health issues*
 - *Financial difficulty; unstable housing*
 - *Generalized aggression or violent acts*
 - *Ongoing efforts to take children from their mother*
 - *History of violence in multiple relationships*
 - *First act of violence is life-threatening or brutal*
 - *Obsessive control of victim's daily activities*
 - *Obsessive jealousy*
 - *Significant and harmful use of a child*
 - *Drawing others into the abuse (e.g., children, family, friends)*
 - *Non-compliance with probation or pre-trial release conditions*

Homicide-Suicide (for male offenders) accounts for 27-32% of the lethal domestic violence incidents

Predominant risk markers include: *guns, patterns of estrangement and reunion and offender's poor mental health.*

Additional risk markers are:

- | | |
|---|---|
| <ul style="list-style-type: none"> • Obsession or jealousy • Alcohol impairment (23 to 38% of perpetrators) • History of domestic violence | <ul style="list-style-type: none"> • Suicide attempts or threats • Personality disorder • Depression of offender (46%) |
|---|---|

Women who kill male partners

Predominant risk markers include: *severe, increasingly frequent, and recent violence by male partner against the defendant; a defendant who is isolated and has few social resources.*

Additional risk markers are:

- | | |
|---|---|
| <ul style="list-style-type: none"> • Access or prior use of weapons • More than 10 violent incidents in the last year at the hands of the person killed • Law enforcement intervention in one or more domestic violence calls in past year | <ul style="list-style-type: none"> • Prior strangulation by person killed • Traditional relationship (married, children, lengthy relationship) • Trapped and isolated in violent relationship • Defendant sought help |
|---|---|

Note: The absence of any of these factors such as "defendant sought help" should not lead to a conclusion that there is no risk. These are not absolute correlations.

J.C. Campbell, D. Webster, et al., "Assessing Risk Factors for Intimate Partner Homicide," NIJ Journal No. 250 (2003): 15-19.

P.R. Kropp, Intimate Partner Violence Risk Assessment and Management, Violence and Victims 23(2), (2008): 202-220.

J. Roehl, C. O'Sullivan, et al., "Intimate Partner Violence Risk Assessment Validation Study, Final Report," (2005).

N. Websdale, "Lethality Assessment Tools: A Critical Analysis," (2000).

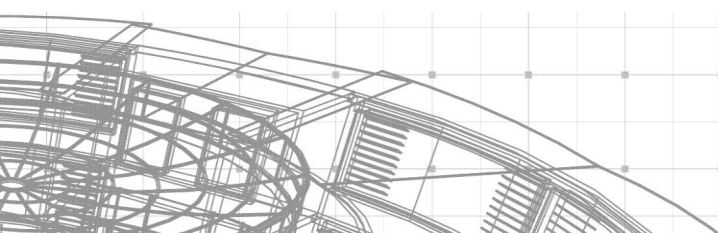

Adapting the *Blueprint for Safety*

The New Orleans *Blueprint for Safety* was developed as part of the *Blueprint* Adaptation Demonstration Initiative under the Department of Justice Office on Violence Against Women. It was adapted from the framework and templates developed by Praxis International and St. Paul, Minnesota, as published by Praxis and available at www.praxisinternational.org.

The *Blueprint* envisions a system in which each practitioner is tuned in to what others can and will likely do when intervening in domestic violence cases. It encourages practitioners to act as a collection of agencies organized around common goals and philosophies. We therefore recommend one reading of the *Blueprint* from start to finish, rather than going only to the section that is specific to your agency or role.

The *Blueprint* is organized around a common framework, “Foundations of Effective Intervention,” as articulated earlier in this chapter, and policies and protocols for each key point of intervention, from 911 to probation and the court. Chapter endnotes referenced throughout the *Blueprint* expand upon and buttress the *Blueprint* as a whole. The endnotes and references prepare those adapting the *Blueprint* to be well-versed in the research, commentary, and national experience that supports the *Blueprint* approach. Research in this field is scattered, filled with contradictions, and often politically charged. The endnotes integrate data from empirical studies, academic research, domestic violence and criminal justice literature, and national resources developed by and for practitioners. The concluding chapter includes the bibliography for all references to research, academic literature, and intervention models cited throughout the *Blueprint*.

The chapters addressing the areas of criminal justice system intervention include polices and related protocols that are anchored in key aspects of the specific agency and practitioner roles in responding to domestic violence cases. Readers will find some repetition in content as the protocols further articulate and define the broad policy language and interagency response.

When a batterer

combines threats or force (coercion) with control, such as “micro-regulating” and “micro-surveillance,” the result is entrapment.

- E. Stark (2007)

Two questions commonly asked regarding adaptation of the Praxis *Blueprint for Safety* and its related templates, training memos, and other supplemental material:

1. Can the *Blueprint* be copied?
2. Can the *Blueprint* be altered?

The answer to question (1) is yes, absolutely. The answer to (2), however, is both yes and no. The New Orleans adaptation illustrates how a final *Blueprint* that has been copied and altered by a community will look.

The foundation for copying or adapting the *Blueprint for Safety* is the version published by Praxis International: www.praxisinternational.org. Any jurisdiction wishing to implement these policies and protocols is encouraged to use and adapt any or all of the language in Chapters 2-8 of the *Blueprint* template, which contain sample policies and protocols. While communities will have to make changes based on state law and terminology and local conditions, some elements of the *Blueprint* cannot be altered. This includes the foundational narrative and its six principles (Chapter One), since they are essential to the *Blueprint's* meaning. In addition, because of the need for precision, a few of the supplemental training memos cannot be altered and are clearly marked as such. When making the cover to your local *Blueprint*, please include: “Adapted from the Saint Paul *Blueprint for Safety*.”

Communities are encouraged to adapt *Blueprint* materials but must receive written permission from Praxis. The front cover, title page, and back cover or page must include the following citation: *Adapted from the Blueprint for Safety as created by Praxis International and the City of Saint Paul, Minnesota.*

The Saint Paul Domestic Abuse Intervention Project (SPIP) has produced a companion piece, *The Distinct and Vital Role of a Legal and System Advocate*, available on its website: www.stpaulblueprintspip.org. This publication helps a community adapting the *Blueprint* to work with independent advocacy programs in an interagency approach to intervention.

For questions regarding adaptation and use of *Blueprint for Safety* materials, please contact Praxis International at blueprint@praxisinternational.org.

A victim's decision

to use the criminal justice system in the future was connected to financial dependence on the perpetrator, safety from abuse during prior interventions, and previous support from practitioners.

– R.E. Fleury-Steiner, et al. (2006)

Chapter One Endnotes

ⁱ “The core tenet of most coordinated criminal justice responses [is] the belief that a criminal justice system that predictably and routinely entangles offenders in multiple ways improves the odds that any given offender will encounter a response that may alter his behavior.” (Worden, 2003, p. 14)

Shepard (1999) offers a brief overview of the components of a coordinated community response (CCR) and how they work. Shepard and Pence (1999) provide more in-depth information on building a CCR.

A number of studies found that a coordinated intervention in domestic violence cases could have a positive, even cumulative, effect on the behavior of the offender (Murphy, et al., 1998, pp. 278-279; Saunders, 2008, p. 165; Syers and Edleson, 1992, p. 484; Tolman and Weisz, 1995, p. 482; Worden, 2003, p. 13; 2001).

Sullivan (2006, p. 205) reports an increased responsiveness to victims and improved interagency interactions through a CCR.

Some studies found CCRs did not fully accomplish their goals or encountered unintended consequences for some victims. These studies are useful to those crafting interagency responses as they help to understand and avoid the pitfalls of this work.

Bouffard and Muftic (2007) report that the effectiveness of a CCR was related to the quality of the batterer’s treatment.

- Salazar et al. (2007) found unintended consequences of CCR efforts when an increase in domestic violence arrests led to a rise in victim arrests.
- An audit of five jurisdictions in CA concluded that batterer intervention programs were not working as intended (California State Auditor, 2006).
- A study of ten CCRs funded by the Centers for Disease Control found great variation in CCR quality, but no significant impact on domestic violence rates overall (Klevens et al., 2008).

The *Greenbook* reports on interagency coordination efforts around the intersection of domestic violence and child maltreatment in six demonstration communities across the U.S. (Edleson et al., 2004, pp. 62-63). While the CCRs were one of the successes of the project, they faced problems with differences in agency structures, philosophies, power, and trust. Participants reported obstacles to collaboration, including: length of the process, lack of time, and differences in organizational cultures.

In a study of interagency coordination, Gondolf (2009) found a number of problems related to personnel issues: new staff and leadership who were unfamiliar with the goals and history of the CCR, varying levels of involvement or resistance, and loss of trained personnel leaving gaps in institutional knowledge. While caseloads increased, there were also interagency barriers: differing intervention priorities, communication breakdowns, and financial stressors.

Worden (2003) mentions unintended consequences and resistance from key leadership as detriments to coordinated intervention. This author recommends caution in selecting outcome measures and definitions of success.

The literature also demonstrates facets of CCRs that work well.

“One large scale study of women in the justice system found that the more battered women perceived different agencies as working together, the more highly they rated them in terms of helpfulness and effectiveness and the more satisfied they were both with the legal system in general and with their own individual case outcomes in particular” (Goodman and Epstein, 2008, p. 85).

Russell and Light (2006) found that victims responded well to police when officers were proactive and part of an integrated team.

Sullivan (2006, p. 205) says “strong leadership, a shared mission, shared power, and a membership extending across more fields” are needed to accomplish goals.

Worden (2003) recommends building on current relationships and resources with a committed core group.

In a review of 41 coordinating councils, Allen (2006, p. 48) concludes that to create an effective CCR requires an inclusive environment, broad participation, and shared decision-making.

- ii While the law brackets physical violence as specific criminal acts, other professional fields use a definition of battering that includes a variety of physical, sexual, and emotional behaviors. For examples, see Asmus et al., 1991; Dutton and Goodman; Follingstad et al., 1990; Johnson and Ferraro; Ptacek, 1999; Russell, 1990; Sullivan, 2006; Stark, 2007; Shepard and Campbell, 1992; Stark and Flitcraft, 1996; Tjaden, 2005.
- iii “A more discriminating understanding of the nature of specific IPV [intimate partner violence] crimes, including the element of coercion, would help secure more appropriate sentencing, as well as treatment for the perpetrators, and more effective safety planning for victims (Erskine, 1999),” (as cited in Dutton, et al., 2005, p. 2).

A major debate in the literature is the efficacy of mandated policies—for both practitioners and victims.

Victims face economic and extralegal household realities that may depend on an intact family unit (Hotelling and Buzawa, 2003, p. 33). For some victims, the ability to drop charges may give them the power they need to negotiate for change in the relationship (Ford, 1991). Other victims face retaliation and rage from offenders for the system’s intervention and expectations of accountability (Ptacek, 1999).

Goodman and Epstein (2008, p. 93) note that, “survivors who are forced into ... inflexible models may well reject them altogether.” In Indianapolis, Ford and Breall (2000, p.8) found that when victims were given a choice of whether or not to drop the charges against the offender, and they chose not to drop the charges, they were less likely to experience re-abuse over the next 6 months.

While some victims are more satisfied with an intervention if they have some control over the system’s response to their case, O’Sullivan, et al. (2007) lay out the complex legal and ethical dilemmas for practitioners facing such requests for flexibility. Their work evaluates victim safety, empowerment, and recidivism for two prosecutorial approaches to filing domestic violence cases.

- iv For example, see the following fatality reports:
 - Minnesota Coalition for Battered Women (http://www.mcbw.org/files/u1/2008_Femicide_Report_FINAL_0.pdf);
 - Washington State Coalition Against Domestic Violence (<http://www.wscadv.org/projects.cfm?aId=390C83A4-C298-58F6-00EC20DCACFA40D5>)
 - Wisconsin Coalition Against Domestic Violence (http://store.wcadv.org/merchant.mvc?Screen=CTGY&StoreCode=WCADV&Category_Code=PUBL-COMP)
 - Additional information and links to domestic violence homicide studies in other states are available from the National Domestic Violence Fatality Review Commission at www.ndvfri.org
- v Stark (2007) estimates that coercive control is involved in at least 60% of domestic violence cases and is probably higher in criminal justice system cases where women seek help.

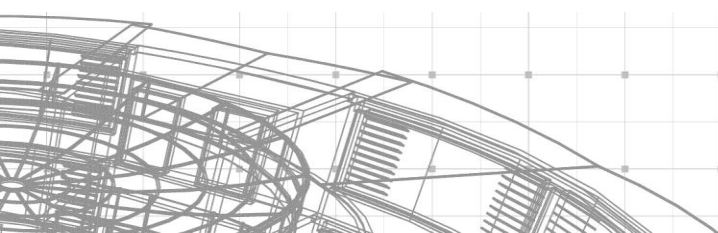

Dutton, et al. (2005, p. 2) argue “that measurement of violent acts alone cannot adequately characterize violence in intimate partner relationships (DeKeseredy and Schwartz, 1998; Dutton, 1996; Edleson and Tolman, 1992; Smith, Smith, and Earp, 1999; Yoshihama, 2000). Rather it is necessary to understand the use of, and response to, IPV in the context of the relationship and the cultural, social, and institutional systems within which the perpetrator and victim live (Dutton, 1996; Edleson and Tolman, 1992).”

Johnson and Ferraro (2000) point out the importance of making distinctions in the motives of the batterer, types of violence that are used, and cultural or social positions of the victim and the perpetrator.

Belknap and Sullivan (2003) reported on non-physical behaviors perpetrated against women in the six months before their partner was arrested. Table 1.6 shows how victims ranked frequency of occurrence for such items as “Tried to control her activities,” “Discouraged her contact with family/ friends,” and “Forbid her from leaving her home.”

Dutton, et al. (2005) reports on the development of a measurement of coercion, demands, and surveillance. Examples of items on their Demand Subscale include “Wearing certain clothes,” “Using street drugs,” “Bathing or using the bathroom.” Coercion Subscale items include threatening harm to partner, self, or others. Surveillance Subscale items include “Kept track of telephone/cell phone use,” “Checked or opened your mail,” or checked the odometer on the car.

vi Websdale (1999) reminds us that homicides are often preceded by multiple criminal justice interventions.

In the Quincy study, Buzawa et al. (1998, p. 189) found about half of the offenders had prior arrests for violent offenses and within two years of the last criminal justice intervention, 44% of the offenders were rearrested for domestic violence.

Hart notes that between the arrest and prosecution, 30% of offenders may re-assault (Goldsmith, 1991, p. 7) and as many as half of domestic violence victims may be threatened with retaliation for cooperation with prosecutors (Davis, et al., 1990, p. 19).

Batterers can reoffend quickly. Goodman and Epstein (2008, p. 75) say that “20% to 30% of arrested offenders re-assault their partners before the court process has concluded or shortly afterward, often as retaliation for involving them in the court system (M.A. Finn, 2003; Ford & Regoli, 1992; Goodman, Bennett, & Dutton, 1999; Hart, 1996).”

According to Gondolf and White, 20% of offenders will re-assault regardless of the intervention (2001, p. 361).

In another study, 14% of the victims reported threats from the perpetrator since disposition of their case, 8% had property damaged, 9% experienced new violence, and 37% of perpetrators had been verbally abusive. (Smith, et al., 2001, p. 72)

Batterers can be very resistant to change despite arrest, intervention, or group treatment. (Goodkind, et al., 2004, p. 515)

Offenders with a ‘stake in conformity’ (employed, married, stable housing) are least likely to reoffend after interaction with the justice system. (Roehl, et al., 2005, p. 14)

However, the high-risk offender with a criminal history tends not to change their behavior with criminal justice intervention. “For high risk offenders, even a ‘model’ court has not broken their pattern of intimidation and control and the interventions they have used to date are insufficient. Stopping chronic and/or serial batterers is apt to be a long, difficult process, not easily impacted by any one criminal justice intervention, especially one that is fundamentally compromised by long prosecutorial and judicial delays and restricted to misdemeanor type sentences.” (Hotelling and Buzawa, 2003, p. 26)

From their study of batterers in four cities, Heckert and Gondolf concluded that “men in the repeat re-assault category were slightly more likely to use a chain of tactics, or multiple tactics, in their violent incidents. That is, their violence was more likely to be excessive and unrelenting.” (2004, p. III-15-8)

Buzawa et al. (1998, pp. 205 and 198) found that courts are most likely to see entrenched batterers who have had prior involvement with the system) and less likely to see those batterers who use occasional violence and have no criminal record. They suggest that the level and conditions of an intervention could be linked to risk markers made visible for each offender.

- vii Stark (2007, p. 94) points out that the harm in domestic violence is not only due to the number of violent events, but to an accumulation of multiple harms. It is the cumulative effect, rather than a set of isolated acts that impact the victim of battering.

Erskine (1999, pp. 1207-1232) discusses the importance of exploring ongoing patterns of intimidation and coercion to determine appropriate charges for a range of criminal or violent behaviors.

A critical part of accurate risk assessment is discussing with the victim her experiences over time and marking changes in frequency and severity. (Block, 2000, p. 290)

- viii When victims are satisfied and work well with the prosecutor’s office, prosecution rates increase, there are a greater number of guilty verdicts, and victims are more likely to report continued abuse. (Buzawa and Buzawa, 2003; Belknap and Graham, 2003; ; O’Sullivan et al., 2007)

However, when a prosecutor and victim want or need different outcomes from intervention, a victim’s “nonparticipation may be chosen in response to the prosecutor’s noncooperation with her plan for securing herself from continuing violence.” (Ford and Breall, 2000, p. 7)

80% of the women who called police wanted protection (Ford and Breall, 2000). But “a battered woman who has made prior attempts to seek prosecution of civil protection orders, only to have the perpetrator escalate his violence, may be unwilling to face the risk that prosecution will further endanger rather than protect her.” (Roehl et al., 2005, p. 15).

Goodman and Epstein (2008, p. 92) explain that when a victim perceives that her needs do not fit what the system offers, “she is likely to feel disserved or even betrayed by the police. [Police] actions may expose her to a wide range of future harms, including retaliatory violence, poverty, homelessness, and loss of community. As a result, [she] may well decline to call the police if she ever again finds herself subjected to intimate partner violence. Her friends, hearing her story, may well do the same.”

Goodman and Epstein (2008, p. 94) go on to explain that “one study ... found that participants who reported feeling in control of the process of working with service providers were far more likely to rate the services they received as helpful and to use them again (Zweig, Burt, & Van Ness, 2003). Similarly, a study within the criminal justice system found that victims who chose not to report recidivist abuse to officials were those who felt they had ‘no voice’ in a previous prosecution.” Also see Belknap and Sullivan (2003, p. 6).

- ix In Indianapolis, Ford and Breall (2008, p. 92) found that any action by the prosecutor lowered the risk of re-abuse by 50% for 6 months.

A victim’s cooperation is affected by delayed hearings, threats, and violence that continue during the process, and perceived lack of attention or support from prosecutors. (Tolman and Weisz, 1995, p. 482) Ultimately, a victim needs to determine whether the system can provide adequate protection against the offenders’ violence.

Fleury-Steiner et al. (2006, pp. 339 and 338) interviewed 178 women whose partners had been through the court system. 19% of these women had been assaulted between the time of the arrest and the closure of the case. The re-abuse continued for 38% of these victims during the first six months after the case

closed and 35% experienced continued abuse in the second six-month period. These researchers concluded that if the system is not able to protect the victim while a case is pending, batterer and victim both receive clear messages about the lack of offender accountability and victim safety.

In making decisions about collaborating in a criminal justice case against the perpetrator, victims face “practical and relational obstacles” such as exposure to retaliation, escalating violence, forced separation, or the financial hardship of an arrest. (Goodman and Epstein, 2008, p. 97; Johnson, 2007, pp. 498-510; Dugan et al., 2003, pp. 20-25; Hart, 1996)

When the case proceeds, a victim may face an increase in controlling behaviors including stalking the loss of victim status, and fears of being arrested or losing custody of the children. (McFarlane, et al., 1999, p. 311; Belknap and Sullivan, 2003, p.10.)

x See Johnson and Ferraro (2000, p. 949); Stark (2007).

xi Worden suggests that “the efficacy of many innovations [in intervention] may be contingent on the consistency of the messages that are exchanged among the victims, offenders, and practitioners” (2003, p. 10).

Interactions with the police create an important baseline for the victim’s level of trust in the rest of system. Belknap and Sullivan (2003) found that whether victims believed the state was a resource for their help seeking was based on positive interaction with an officer who listened without judgment and communicated empathy. Victims saw police as helpful when they provided legal information, advocacy support, attended to medical care, and paid attention to the needs of the children.

Goodman and Epstein (2008, p. 78) note, “Other research has shown that women who experience government officials as listening to their stories and responding to their individual needs are more likely to feel treated fairly and therefore to cooperate with the prosecutor’s requests than are women who feel forced into a mandatory model dismissive of their input (Erez & Belknap, 1998; Ford & Regoli, 1993).” A perpetrator may not stop battering the victim, but victims do not stop working toward non-violence. (Campbell et al., 1998, pp. 743-762).

Goodkind et al. (2004) studied the safety planning strategies victims with children used; in particular, see Table 1: Safety Planning Strategies Endorsed and Consequence of Using Strategy (p. 520).

Researchers at Texas Women’s University (2003) designed a one-hour phone contact for use with the victim during the processing of a protection order. Their study demonstrated that “abused women offered a safety intervention at the time of applying for a protection order quickly adopt safety behaviors and continued to practice those safety behaviors for eighteen months” (p.8).

Practitioners can support a victim’s safety planning by providing tactical information about the legal process, legal options, appropriate referrals, and specific communication about the risk of severe violence and lethality. (Johnson, 2007; Kropp, 2008, p. 213)

xii Gondolf (2004) noted a reduction in no-shows and improved completion rates of batterer intervention programs when offenders moved through the system quickly. When intervention was swift and certain, the rate of offenders entering the groups increased from 70% to 95% and the completion rate rose to 70% (p. 619). Gondolf linked the effectiveness of batterer programs to a streamlined system where violations were treated with a ‘swift and certain’ response, offenders identified as high risk received increased sanctions, and risk markers were monitored throughout the intervention (see discussion on page 624).

Two additional studies by Gondolf (2000; 1999) verify the impact of swift and sure response for domestic violence offenders.

In domestic violence cases, the specific language of swift and sure is not commonly used, but several authors do recommend aggressive or prompt response to violations of court orders. (Buzawa et al., 2000; Hofford, 1991, pp. 12-17) One of the four lessons reported from the Judicial Oversight Demonstration project was the importance of “procedures to monitor or educate defendants and provide a quick court response to violations of no-contact orders and other bond conditions.” (Visher et al., 2007, p. 9)

To review a theoretical frame for choice theory and negative sanctions see Pratt (2008) and Kurbrin, et al. (2009). A research study conducted by Weisburd, et al. (2008) demonstrated the impact of swift and certain responses to probation violators.

- xiii In their seminal study of the criminal justice system in Quincy, MA, Buzawa et al. (2000, pp. 9, 10, 18, and 12) found that 84% of offenders had prior arrests, 54% had six or more prior charges, and 14% had at least 30 criminal charges. In the Quincy study, nearly three-quarters of the victims had made prior calls to the police about that perpetrator. “Less than half the victims were living with the offender at the time of incident, but three-fourths of victimizations occurred in their homes.” Even as a model proactive court, in Quincy “the system does not appear to prevent recidivism among ‘hard-core’ re-offenders.” The population of batterers in that study recidivated within one month after arrest.

Bouffard and Muftic (2007, p. 364) reported that batterers who had been in the system with a prior domestic violence case were significantly more likely to be no-shows for batterer group intake than those without a domestic violence record.

- xiv Dutton and Goodman (2005) describe a process of coercion and control created by both demands and threats: threats that the victim knows from past experience to be credible. In summary, a history of exposure to negative consequences from previous threats assures compliance with future demands. This dynamic of threats and consequences form a “cumulative pattern” of control that is not dependent on physical contact. To break that pattern, the victim assesses resources and options for safety that are as credible as the perpetrator’s threats. For additional information about the process of coercion and control, see Dutton et al. (2005) and Stark (2007).

- xv In his observation of courtroom interactions in domestic violence cases, Ptacek (1999, pp. 172-178) studied how the interaction between judges, victims, and offenders can support or deter the battering dynamic. He points out that the behaviors demonstrated in the courtroom can (intentionally or not) become another resource the perpetrator can use for intimidation or coercion in the future. To that extent, a victim’s experience of the criminal justice intervention can reaffirm the perpetrator’s messages. Ptacek created a graphic titled “Judicial Responses that Reinforce Women’s Entrapment” to describe some of the behaviors he observed. To demonstrate the potential parallels that victims may find in criminal justice interventions, he lays the judge’s behaviors alongside behaviors used by perpetrators. Ptacek’s graphic is available in a report by Levey, et al. (2000, p. Appendix I-2).

- xvi Descriptors of entitlement are found in the writings of practitioners with extensive experience facilitating batterer intervention programs. These practitioners are in agreement about entitlement as a foundational element of battering. Bancroft (2002, p. 54) describes entitlement as a belief (and attitude) that the batterer alone has the right to privilege and status in this relationship.

F. Mederos (2004, p. 15) adds that entitlement is the expectation that a partner will fulfill a specific (gendered) role in the relationship and that the perpetrator has the right to use violence, anger, or other forms of abuse for failure to meet those expectations.

Also see Pence and Paymar (1993).

- xvii 49% of batterer groups use a cognitive-behavioral approach. (Saunders, 2008. p.157).

From a longitudinal study of batterer programs, Gondolf (2004, p. 623) concluded that cognitive-behavioral programs for batterers were the most commonly used, effective for most offenders, and less

costly to administer. Also see Hamberger (1997); Pence and Paymar (1993); Sullivan (2006, p. 204); White and Gondolf (2000).

^{xviii} “Violence is simply a tool ... that the perpetrator uses to gain greater power in the relationships to deter or trigger specific behaviors, win arguments, or demonstrate dominance.” (Dutton, et al., 2005) In the development of a coercion scale, these same authors identified nine areas where offenders focused demands on victims: personal activities and appearance, support systems, household responsibilities, economic resources and work, health, physical intimacy, legal help seeking, immigration, and children or parenting (pp.1-3).

Stark (2007, pp. 228-278) argues that in large part the historic concept of domination has been replaced by coercive control: coercion as force or threats used to yield a desired response and control as both structural and tactical. Control could involve deprivation, manipulation, demanding compliance while controlling resources, behaviors, and support systems. Stark uses the terms microregulating and microsurveillance to emphasize the intrusion of coercive acts in the lives of victims. When combined, the product of coercion and control is entrapment.

^{xix} Dutton and Goodman (2005, p. 747) point out that a victim’s cultural, religious, and economic realities give coercive tactics and threats their meaning.

For a listing of control tactics embedded in messages that are used by perpetrators before and after criminal justice intervention. See Table 1.6 in Belknap and Sullivan. (2003, n.p.)

^{xx} Fleury-Steiner et al. (2006, p. 329) found that a victim’s decision to use the criminal justice system in the future was connected to their financial dependence on the perpetrator, safety from abuse during prior interventions, and support from practitioners.

One of the conclusions from the Judicial Oversight Demonstration Initiative was that judges can make a difference in victim safety and offender accountability. (Visher et al., 2007, p. 2)

From observations of restraining order hearings in Dorchester and Quincy, MA, Ptacek (1999) identified five types of authority judges present to victims and offenders. The messages carried by the court’s demeanor can be of believability, support, seriousness of the charge, or a dismissive ‘wink and a nod.’ The court’s response to a victim can counteract messages of the batter, but are particularly important information for the victim’s strategic planning.

Victims fear that criminal justice practitioners will believe the offender, not make an arrest, or take no action. (Russell and Light, 2006, p. 389)

Prosecutors send clear messages by communicating to the victim how the criminal justice system works and just what it can and cannot do. (Hoteling and Buzawa, 2003, p. 38)

Messages of support are also sent through the types of institutional resources that are offered: advocacy, culturally sensitive programs and referrals, translation and TDDY services, etc.

^{xxi} Colia Ceisel (Public Defender Ramsey County, Retired), Presentation at Saint Paul Police Department Training, June 28, 2009. For more discussion on batterers’ defenses of violence, see Bancroft (2002, pp. 296-301); Buzawa and Buzawa (2003, pp. 147-148); and Loue (2001, p. 119).

^{xxii} Colia Ceisel (Public Defender Ramsey County, Retired), Presentation at Saint Paul Police Department Training, June 28, 2009. For more on batterers’ defenses of violence, see Bancroft (2002, pp. 296-301); Buzawa and Buzawa (2003, pp. 147-148); and Loue (2001, p. 119).

^{xxiii} Violence Policy Center (2014), p. 6.

^{xxiv} Violence Policy Center (2014), p. 6.

^{xxv} For a summary of homicide trends in intimate relationships, visit the Bureau of Justice Statistics report at <http://www.ojp.usdoj.gov/bjs/homicide/intimates.htm>

For a discussion of national data sources and statistics, see Stark (2007 pp. 53-56).

^{xxvi} For more information on using the Guide to Risk and Danger, see *Training Memo – Risk and Dangerousness: Managing Severe or Lethal Violence*, at <http://www.praxisinternational.org/files/praxis/files/Blueprint/BPTrainingMemoRiskandDangerousness1BOct2013.pdf>

^{xxvii} Weitz, Tolman, and Saunders (2000); Heckert & Gondolf (2004); Roehl, et. al (2005)